

Part No:	GH-12132
Holding Capacity:	227Kg
Bar Opens:	100°
Handle Opens:	56°
Weight:	0.37Kg
Spindle Supplied:	FC-086312
Flanged Washers:	FW-516

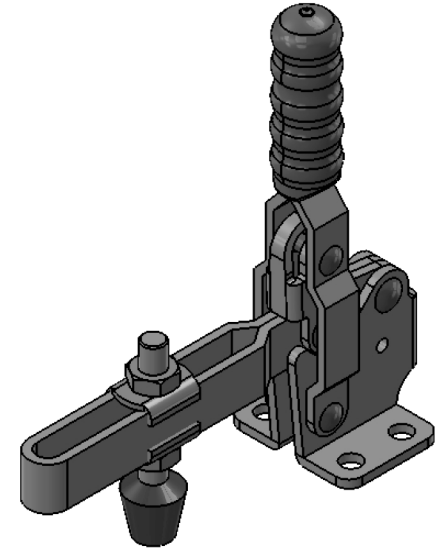
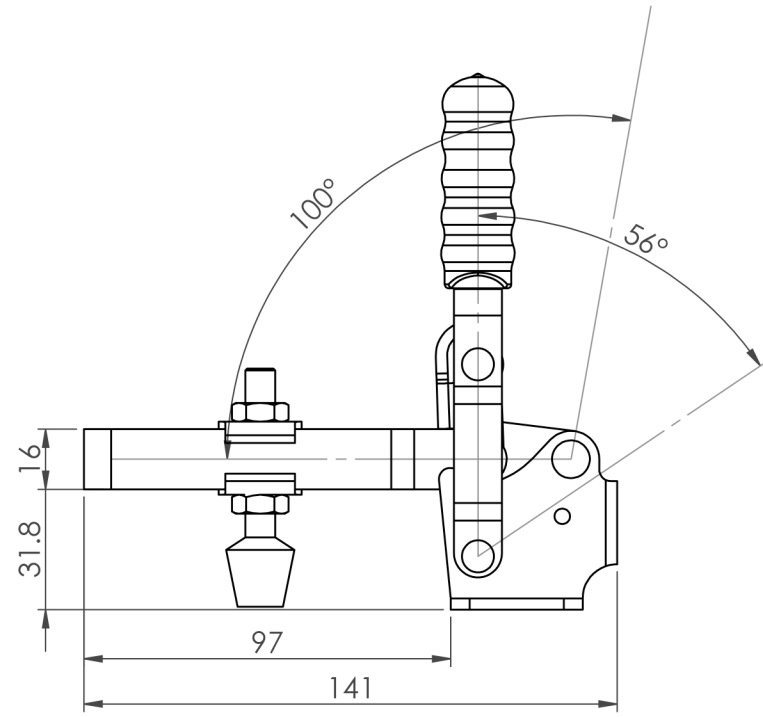
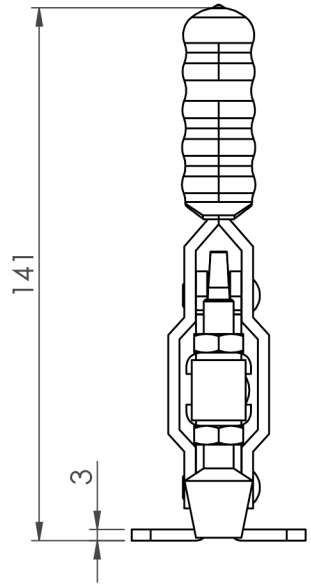
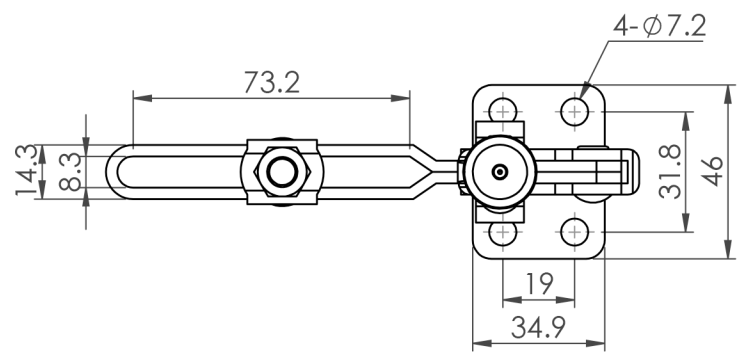

Unit:mm
Scale: 1:2

TITLE:	
DWG NO.	GH-12132
	A4